

CAT. N° 5 732 84



## MASTER SWITCH ARTEOR - LIGHTING CONTROL - 2 MODULES - WHITE

Pack (number of units)	10
Volume (dm <sup>3</sup> )	1,581
Weight (g)	513,00

### Product characteristics

#### Lighting control

##### Master switch - 2 modules

- 2-way double pole
- 20 AX - 250 V~ for general control: all ON / all OFF
- White

### General characteristics

#### Hotel equipment - Arteor wiring devices square version

- Mechanisms supplied with rocker plates, to be equipped with support frames and plates

### Documentation



#### Catalogue pages & additional information

- [Description page \(p.440\)](#)



#### Agreements & certificates of conformity

- [OC / CB - FR\\_705038/A1](#)

CAT. N° 5 737 84



## MASTER SWITCH ARTEOR FOR LIGHTING CONTROL - 2 MODULES - MAGNESIUM

Pack (number of units)	10
Volume (dm <sup>3</sup> )	1,581
Weight (g)	512,00

### Product characteristics

#### Lighting control

##### Master switch - 2 modules

- 2-way double pole
- 20 AX - 250 V~ for general control: all ON / all OFF
- Magnesium

### General characteristics

#### Hotel equipment - Arteor wiring devices square version

- Mechanisms supplied with rocker plates, to be equipped with support frames and plates

### Documentation



#### Catalogue pages & additional information

- [Description page \(p.440\)](#)



#### Agreements & certificates of conformity

- [OC / CB - FR\\_705038/A1](#)

CAT. N° 5 737 89



## MASTER SWITCH ARTEOR FOR LIGHTING CONTROL - 2 MODULES - CHAMPAGNE

Pack (number of units)	O/R
Volume (dm <sup>3</sup> )	O/R
Weight (g)	O/R

### Product characteristics

#### Lighting control

##### Master switch - 2 modules

- 2-way double pole
- 20 AX - 250 V~ for general control: all ON / all OFF
- Champagne

### General characteristics

#### Hotel equipment - Arteor wiring devices square version

- Mechanisms supplied with rocker plates, to be equipped with support frames and plates

### Documentation

CAT. N° 5 737 88



## MASTER SWITCH ARTEOR FOR LIGHTING CONTROL - 2 MODULES - SOFT ALU

Pack (number of units)	O/R
Volume (dm <sup>3</sup> )	O/R
Weight (g)	O/R

### Product characteristics

#### Lighting control

##### Master switch - 2 modules

- 2-way double pole
- 20 AX - 250 V~ for general control: all ON / all OFF
- Soft Alu

### General characteristics

#### Hotel equipment - Arteor wiring devices square version

- Mechanisms supplied with rocker plates, to be equipped with support frames and plates

### Documentation

CAT. N° 5 732 86

**MASTER PUSH-BUTTON ARTEOR - LIGHTING CONTROL -  
2 MODULES - WHITE**

Pack (number of units)	10
Volume (dm <sup>3</sup> )	1,581
Weight (g)	377,00

**Product characteristics****Lighting control****Master push-button - 2 modules**

- 2-way
- 6 A - 250 V~ for general control: all ON/ all OFF
- White

**General characteristics****Hotel equipment - Arteor wiring devices square  
version**

- Mechanisms supplied with rocker plates, to be equipped with support frames and plates

**Documentation****Catalogue pages & additional information**

- [Description page \(p.440\)](#)

**Agreements & certificates of conformity**

- [OC / CB - FR\\_705038/A1](#)

CAT. N° 5 737 86



## MASTER PUSH-BUTTON ARTEOR FOR LIGHTING CONTROL - 2 MODULES - MAGNESIUM

Pack (number of units)	10
Volume (dm <sup>3</sup> )	1,581
Weight (g)	380,00

### Product characteristics

#### Lighting control

##### Master push-button - 2 modules

- 2-way
- 6 A - 250 V~ for general control: all ON/ all OFF
- Magnesium

### General characteristics

#### Hotel equipment - Arteor wiring devices square version

- Mechanisms supplied with rocker plates, to be equipped with support frames and plates

### Documentation



#### Catalogue pages & additional information

- [Description page \(p.440\)](#)



#### Agreements & certificates of conformity

- [OC / CB - FR\\_705038/A1](#)

CAT. N° 5 737 99



## MASTER PUSH-BUTTON ARTEOR FOR LIGHTING CONTROL - 2 MODULES - CHAMPAGNE

Pack (number of units)	O/R
Volume (dm <sup>3</sup> )	O/R
Weight (g)	O/R

### Product characteristics

#### Lighting control

##### Master push-button - 2 modules

- 2-way
- 6 A - 250 V~ for general control: all ON/ all OFF
- Champagne

### General characteristics

#### Hotel equipment - Arteor wiring devices square version

- Mechanisms supplied with rocker plates, to be equipped with support frames and plates

### Documentation

CAT. N° 5 737 98



## MASTER PUSH-BUTTON ARTEOR FOR LIGHTING CONTROL - 2 MODULES - SOFT ALU

Pack (number of units)	O/R
Volume (dm <sup>3</sup> )	O/R
Weight (g)	O/R

### Product characteristics

#### Lighting control

##### Master push-button - 2 modules

- 2-way
- 6 A - 250 V~ for general control: all ON/ all OFF
- Soft Alu

### General characteristics

#### Hotel equipment - Arteor wiring devices square version

- Mechanisms supplied with rocker plates, to be equipped with support frames and plates

### Documentation



CAT. N° 5 732 94

**SWITCH FOR BED LIGHTS ARTEOR - LIGHTING CONTROL  
- 2 X 1 MODULE - WHITE**

Pack (number of units)	5
Volume (dm <sup>3</sup> )	0,758
Weight (g)	265,00

**Product characteristics****Lighting control****Switch for bed lights - 2 x 1 module**

- 2 x 2-way switch - 10 AX - 250 V~
- White

**General characteristics****Hotel equipment - Arteur wiring devices square version**

- Mechanisms supplied with rocker plates, to be equipped with support frames and plates

**Documentation****Catalogue pages & additional information**

- [Description page \(p.440\)](#)

**Agreements & certificates of conformity**

- [OC / CB - FR\\_705038/A1](#)

CAT. N° 5 737 94

**SWITCH FOR BED LIGHTS ARTEOR FOR LIGHTING CONTROL - 2 X 1 MODULE - MAGNESIUM**

Pack (number of units)	5
Volume (dm <sup>3</sup> )	0,758
Weight (g)	263,00

**Product characteristics****Lighting control****Switch for bed lights - 2 x 1 module**

- 2 x 2-way switch - 10 AX - 250 V~
- Magnesium

**General characteristics****Hotel equipment - Arteor wiring devices square version**

- Mechanisms supplied with rocker plates, to be equipped with support frames and plates

**Documentation****Catalogue pages & additional information**

- [Description page \(p.440\)](#)

**Agreements & certificates of conformity**

- [OC / CB - FR\\_705038/A1](#)

CAT. N° 5 737 63

**SWITCH FOR BED LIGHTS ARTEOR - LIGHTING CONTROL  
- 2 X 1 MODULE - CHAMPAGNE**

Pack (number of units)	O/R
Volume (dm <sup>3</sup> )	O/R
Weight (g)	O/R

**Product characteristics****Lighting control****Switch for bed lights - 2 x 1 module**

- 2 x 2-way switch - 10 AX - 250 V~
- Champagne

**General characteristics****Hotel equipment - Arteur wiring devices square version**

- Mechanisms supplied with rocker plates, to be equipped with support frames and plates

**Documentation**

CAT. N° 5 737 62

**SWITCH FOR BED LIGHTS ARTEOR - LIGHTING CONTROL  
- 2 X 1 MODULE - SOFT ALU**

Pack (number of units)	O/R
Volume (dm <sup>3</sup> )	O/R
Weight (g)	O/R

**Product characteristics****Lighting control****Switch for bed lights - 2 x 1 module**

- 2 x 2-way switch - 10 AX - 250 V~
- Soft Alu

**General characteristics****Hotel equipment - Arteur wiring devices square version**

- Mechanisms supplied with rocker plates, to be equipped with support frames and plates

**Documentation**

# Arteor™ Control for hotel equipment

Cat. No(s): 5 722 01/02/19/20 - 5 727 01/02/19/20  
 5 732 19/20/22/23/24/25/34/35/36/37  
 5 737 19/20/22/23/24/25/34/35/36/37

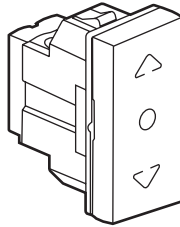

5 722 01 - 5 727 01

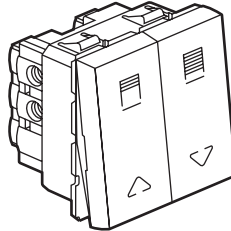

5 732 22 - 5 737 22

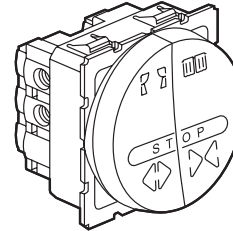

5 732 37 - 5 737 37

## 1. USE

Control (up, down, stop) for awnings, roller shutters, etc.  
 Double two-way switch for direct control of a motor (mechanism with fixed positions).  
 The mechanisms can be flush-mounted or surface-mounted.

## 2. RANGE

	Description	White	Magnesium
	Curtain switch Center retract Square - 1 module	5 722 01	5 727 01
	Curtain switch Center OFF Square - 1 module	5 722 02	5 727 02
	Double push for electric shutter Square - 2 modules	5 722 19	5 727 19
	Double switch for electric shutter Square - 2 modules	5 722 20	5 727 20
	Double push for electric shutter Round - 2 modules	5 732 19	5 737 19
	Double switch for electric shutter Round - 2 modules	5 732 20	5 737 20
	Double switch Roller blinds marking Square - 2 modules	5 732 22	5 737 22
	Double switch Roller blinds marking Round - 2 modules	5 732 23	5 737 23
	Double push Roller blinds marking Square - 2 modules	5 732 24	5 737 24
	Double push Roller blinds marking Round - 2 modules	5 732 25	5 737 25

## 2. RANGE (continued)

	Description	White	Magnesium
	Double switch Curtain marking Square - 2 modules	5 732 34	5 737 34
	Double switch Curtain marking Round - 2 modules	5 732 35	5 737 35
	Double push Curtain marking Square - 2 modules	5 732 36	5 737 36
	Double push Curtain marking Round - 2 modules	5 732 37	5 737 37

## 3. OVERALL DIMENSIONS (mm)

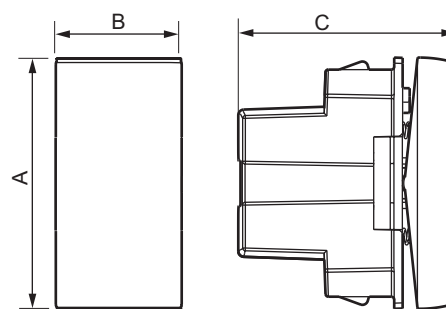

	A	B	C
1 module	45	22.5	39
2 modules	45	45	42

#### 4. CONNECTION

Number of terminals: 3  
 Type of terminals: with screws  
 Terminal capacity: 2 x 1.5 mm<sup>2</sup> or 1 x 1.4 mm<sup>2</sup>  
 Stripping length:  
 - 8 mm for 5 722 01/02 - 5 727 01/02  
 - 10 mm for 5 722 19/20- 5 727 19/20  
     5 732 19/20/22/23/24/25/34/35/36/37  
     5 737 19/20/22/23/24/25/34/35/36/37  
 Type of screwdriver: flat-blade screwdriver 4 mm up to 5.5 mm

##### ■ 4.1 Control of an electronic control box

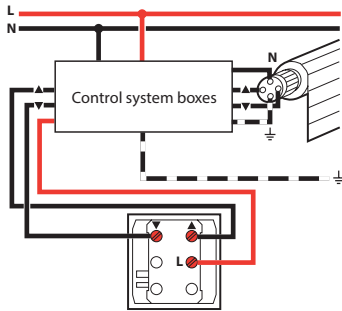

For: 5 722 01/19 - 5 732 19/24/25/36/37  
 5 727 01/19 - 5 737 19/24/25/36/37

##### ■ 4.2 Direct control of a motor

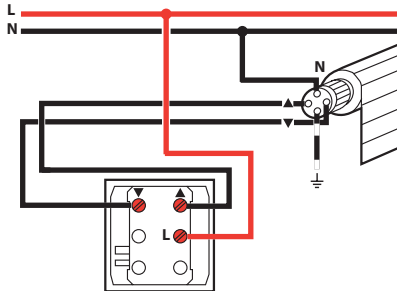

For: 5 722 02/20 - 5 732 20/22/23/34/35  
 5 727 02/20 - 5 737 20/22/23/34/35

#### 5. OPERATION

Used for direct and individual control of a roller shutter motor.  
 Fitted with two switches linked by a system preventing simultaneous pressing of both switches STOP control is obtained by opening both switches.

#### 6. TECHNICAL CHARACTERISTICS

##### ■ 6.1 Mechanical characteristics

Protection against solid bodies and liquids: IP 40 (mounted)  
 IP 20 (alone)

Impact test: IK 04

##### ■ 6.2 Material characteristics

Rocker: Polycarbonate  
 Base: Polycarbonate  
 Self-extinguishing:  
 + 850° C / 30 s for insulating parts holding live parts in place.  
 + 650° C / 30 s for other parts made of insulating materials.

##### ■ 6.3 Electrical characteristics

Voltage: 250 Vac  
 Current: 10 A  
 6 A for Cat. No(s) 5 722 01 - 5 727 01

##### ■ 6.4 Climatic characteristics

Storage and operating temperatures: - 20° C to + 40° C

#### 7. CLEANING

Surface cleaning with a cloth.

Do not use: acetone, tar remover, trichloroethylene.

Resistance to the following agents: Hexane (EN-60669-1),  
 Methylated spirits, Soapy water, diluted ammonia, diluted pure bleach  
 10%, Glass cleaning substance, Pre-impregnated wipes.

**Caution:** A preliminary test should be carried out if other specific cleaning products are to be used.

# Arteor™ Control for hotel equipment

Cat. No(s): 5 722 01/02/19/20 - 5 727 01/02/19/20  
 5 732 19/20/22/23/24/25/34/35/36/37  
 5 737 19/20/22/23/24/25/34/35/36/37

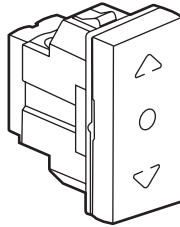

5 722 01 - 5 727 01

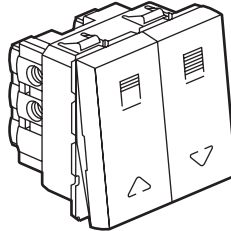

5 732 22 - 5 737 22

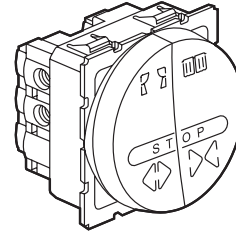

5 732 37 - 5 737 37

## 1. USE

Control (up, down, stop) for awnings, roller shutters, etc.  
 Double two-way switch for direct control of a motor (mechanism with fixed positions).  
 The mechanisms can be flush-mounted or surface-mounted.

## 2. RANGE

	Description	White	Magnesium
	Curtain switch Center retract Square - 1 module	5 722 01	5 727 01
	Curtain switch Center OFF Square - 1 module	5 722 02	5 727 02
	Double push for electric shutter Square - 2 modules	5 722 19	5 727 19
	Double switch for electric shutter Square - 2 modules	5 722 20	5 727 20
	Double push for electric shutter Round - 2 modules	5 732 19	5 737 19
	Double switch for electric shutter Round - 2 modules	5 732 20	5 737 20
	Double switch Roller blinds marking Square - 2 modules	5 732 22	5 737 22
	Double switch Roller blinds marking Round - 2 modules	5 732 23	5 737 23
	Double push Roller blinds marking Square - 2 modules	5 732 24	5 737 24
	Double push Roller blinds marking Round - 2 modules	5 732 25	5 737 25

## 2. RANGE (continued)

	Description	White	Magnesium
	Double switch Curtain marking Square - 2 modules	5 732 34	5 737 34
	Double switch Curtain marking Round - 2 modules	5 732 35	5 737 35
	Double push Curtain marking Square - 2 modules	5 732 36	5 737 36
	Double push Curtain marking Round - 2 modules	5 732 37	5 737 37

## 3. OVERALL DIMENSIONS (mm)

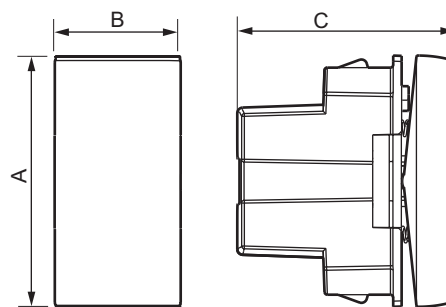

	A	B	C
1 module	45	22.5	39
2 modules	45	45	42

#### 4. CONNECTION

Number of terminals: 3  
 Type of terminals: with screws  
 Terminal capacity: 2 x 1.5 mm<sup>2</sup> or 1 x 1.4 mm<sup>2</sup>  
 Stripping length:  
 - 8 mm for 5 722 01/02 - 5 727 01/02  
 - 10 mm for 5 722 19/20- 5 727 19/20  
     5 732 19/20/22/23/24/25/34/35/36/37  
     5 737 19/20/22/23/24/25/34/35/36/37  
 Type of screwdriver: flat-blade screwdriver 4 mm up to 5.5 mm

##### ■ 4.1 Control of an electronic control box

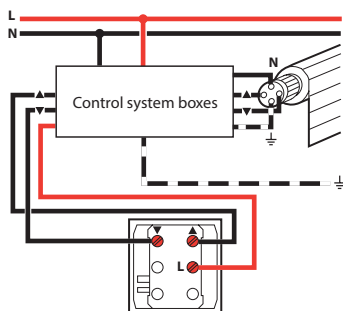

For: 5 722 01/19 - 5 732 19/24/25/36/37  
 5 727 01/19 - 5 737 19/24/25/36/37

##### ■ 4.2 Direct control of a motor

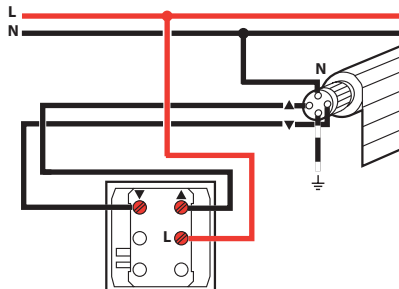

For: 5 722 02/20 - 5 732 20/22/23/34/35  
 5 727 02/20 - 5 737 20/22/23/34/35

#### 5. OPERATION

Used for direct and individual control of a roller shutter motor.  
 Fitted with two switches linked by a system preventing simultaneous pressing of both switches STOP control is obtained by opening both switches.

#### 6. TECHNICAL CHARACTERISTICS

##### ■ 6.1 Mechanical characteristics

Protection against solid bodies and liquids: IP 40 (mounted)  
 IP 20 (alone)

Impact test: IK 04

##### ■ 6.2 Material characteristics

Rocker: Polycarbonate  
 Base: Polycarbonate  
 Self-extinguishing:  
 + 850° C / 30 s for insulating parts holding live parts in place.  
 + 650° C / 30 s for other parts made of insulating materials.

##### ■ 6.3 Electrical characteristics

Voltage: 250 Vac  
 Current: 10 A  
 6 A for Cat. No(s) 5 722 01 - 5 727 01

##### ■ 6.4 Climatic characteristics

Storage and operating temperatures: - 20° C to + 40° C

#### 7. CLEANING

Surface cleaning with a cloth.

Do not use: acetone, tar remover, trichloroethylene.

Resistance to the following agents: Hexane (EN-60669-1),  
 Methylated spirits, Soapy water, diluted ammonia, diluted pure bleach  
 10%, Glass cleaning substance, Pre-impregnated wipes.

**Caution:** A preliminary test should be carried out if other specific cleaning products are to be used.



CAT. N° 5 720 57



## HOTEL BEDROOM CALL INDICATOR - LAMP+BELL PUSH - 2 MODULES - WHITE

Pack (number of units)	5
Volume (dm <sup>3</sup> )	0,898
Weight (g)	282,00

### Product characteristics

#### Hotel bedroom call indicators

- Enable the resident to inform hotel staff of the room status
- Two settings are possible:
  - Do not disturb
  - Please clean the room
- 2 x 1 module

#### Indicator for corridor

- Indicator lamp and bell push
- Installed in the corridor, display calls
- Supplied with LED
- White

### General characteristics

#### Hotel equipment - Arteor wiring devices square version

- Mechanisms supplied with rocker plates, to be equipped with support frames and plates

### Documentation

#### Catalogue pages & additional information

- [Description page \(p.440\)](#)

#### Agreements & certificates of conformity

- [OC / CB - CN51287](#)
- [OC / CB - SE-88889](#)
- [CCC - 2002010202027257](#)
- [OC / CB - CN16969](#)
- [OC / CB - CN16969-M1](#)

#### Installation instructions & related documents

- [LE01561AB](#)

CAT. N° 5 725 57



## HOTEL BEDROOM CALL INDICATOR - LAMP+BELL PUSH - 2 MODULES - MAGNESIUM

Pack (number of units)	5
Volume (dm <sup>3</sup> )	0,898
Weight (g)	283,00

### Product characteristics

#### Hotel bedroom call indicators

- Enable the resident to inform hotel staff of the room status
- Two settings are possible:
  - Do not disturb
  - Please clean the room
- 2 x 1 module

#### Indicator for corridor

- Indicator lamp and bell push
- Installed in the corridor, display calls
- Supplied with LED
- Magnesium

### General characteristics

#### Hotel equipment - Arteor wiring devices square version

- Mechanisms supplied with rocker plates, to be equipped with support frames and plates

### Documentation

#### Catalogue pages & additional information

- [Description page \(p.440\)](#)

#### Agreements & certificates of conformity

- [OC / CB - CN51287](#)
- [OC / CB - SE-88889](#)
- [CCC - 2002010202027257](#)
- [OC / CB - CN16969](#)
- [OC / CB - CN16969-M1](#)

#### Installation instructions & related documents

- [LE01561AB](#)

CAT. N° 5 737 78



## HOTEL BEDROOM CALL INDICATOR - LAMP + BELL PUSH - 2 MODULES - CHAMPAGNE

Pack (number of units)	5
Volume (dm <sup>3</sup> )	0,898
Weight (g)	252,00

### Product characteristics

#### Hotel bedroom call indicators

- Enable the resident to inform hotel staff of the room status
- Two settings are possible:
  - Do not disturb
  - Please clean the room
- 2 x 1 module

#### Indicator for corridor

- Indicator lamp and bell push
- Installed in the corridor, display calls
- Supplied with LED
- Champagne

### General characteristics

#### Hotel equipment - Arteur wiring devices square version

- Mechanisms supplied with rocker plates, to be equipped with support frames and plates

### Documentation

CAT. N° 5 737 77



## HOTEL BEDROOM CALL INDICATOR - LAMP + BELL PUSH - 2 MODULES - SOFT ALU

Pack (number of units)	O/R
Volume (dm <sup>3</sup> )	O/R
Weight (g)	O/R

### Product characteristics

#### Hotel bedroom call indicators

- Enable the resident to inform hotel staff of the room status
- Two settings are possible:
  - Do not disturb
  - Please clean the room
- 2 x 1 module

#### Indicator for corridor

- Indicator lamp and bell push
- Installed in the corridor, display calls
- Supplied with LED
- Soft Alu

### General characteristics

#### Hotel equipment - Arteor wiring devices square version

- Mechanisms supplied with rocker plates, to be equipped with support frames and plates

### Documentation

CAT. N° 5 720 54

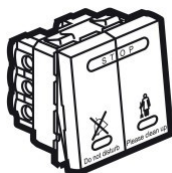

## HOTEL BEDROOM CALL INDICATOR - INTERNAL CONTROL UNIT - 2 MODULES - WHITE

Pack (number of units)	5
Volume (dm <sup>3</sup> )	1,39
Weight (g)	300,00

### Product characteristics

#### Hotel bedroom call indicators

- Enable the resident to inform hotel staff of the room status
- Two settings are possible:
  - Do not disturb
  - Please clean the room
- 2 x 1 module

#### Internal control unit

- Allows the user to select the desired setting
- Supplied with LED
- White

### General characteristics

#### Hotel equipment - Arteor wiring devices square version

- Mechanisms supplied with rocker plates, to be equipped with support frames and plates

### Documentation

#### Catalogue pages & additional information

- [Description page \(p.440\)](#)

#### Agreements & certificates of conformity

- [OC / CB - FR\\_705038/A1](#)

#### Installation instructions & related documents

- [LE01561AB](#)

CAT. N° 5 737 82



## HOTEL BEDROOM CALL INDICATOR - INTERNAL CONTROL UNIT - 2 MODULES - CHAMPAGNE

Pack (number of units)	O/R
Volume (dm <sup>3</sup> )	O/R
Weight (g)	O/R

### Product characteristics

#### Hotel bedroom call indicators

- Enable the resident to inform hotel staff of the room status
- Two settings are possible:
  - Do not disturb
  - Please clean the room
- 2 x 1 module

#### Internal control unit

- Allows the user to select the desired setting
- Supplied with LED
- Champagne

### General characteristics

#### Hotel equipment - Arteor wiring devices square version

- Mechanisms supplied with rocker plates, to be equipped with support frames and plates

### Documentation

CAT. N° 5 725 54



## HOTEL BEDROOM CALL INDICATOR - INTERNAL CONTROL UNIT - 2 MODULES - MAGNESIUM

Pack (number of units)	5
Volume (dm <sup>3</sup> )	1,39
Weight (g)	299,00

### Product characteristics

#### Hotel bedroom call indicators

- Enable the resident to inform hotel staff of the room status
- Two settings are possible:
  - Do not disturb
  - Please clean the room
- 2 x 1 module

#### Internal control unit

- Allows the user to select the desired setting
- Supplied with LED
- Magnesium

### General characteristics

#### Hotel equipment - Arteor wiring devices square version

- Mechanisms supplied with rocker plates, to be equipped with support frames and plates

### Documentation

#### Catalogue pages & additional information

- [Description page \(p.440\)](#)

#### Agreements & certificates of conformity

- [OC / CB - FR\\_705038/A1](#)

#### Installation instructions & related documents

- [LE01561AB](#)

CAT. N° 5 737 81



## HOTEL BEDROOM CALL INDICATOR - INTERNAL CONTROL UNIT - 2 MODULES - SOFT ALU

Pack (number of units)	O/R
Volume (dm <sup>3</sup> )	O/R
Weight (g)	O/R

### Product characteristics

#### Hotel bedroom call indicators

- Enable the resident to inform hotel staff of the room status
- Two settings are possible:
  - Do not disturb
  - Please clean the room
- 2 x 1 module

#### Internal control unit

- Allows the user to select the desired setting
- Supplied with LED
- Soft Alu

### General characteristics

#### Hotel equipment - Arteor wiring devices square version

- Mechanisms supplied with rocker plates, to be equipped with support frames and plates

### Documentation



CAT. N° 5 722 24



## ILLUMINATED SIGNS ARTEOR - 1 W- 2-STATE LEDS GREEN/RED - 2 MODULES - WHITE

Pack (number of units)	5
Volume (dm <sup>3</sup> )	0,758
Weight (g)	242,00

### Product characteristics

#### Illuminated signs

- Mechanisms integrating LEDs and a pivoting window that can take customised labels (printed using a simple text editor on transparent printing paper)
- 2 modules

#### Green or red LEDs

- Sign with 2-state LEDs with choice of green or red configurable on the mechanism
- Power level: 1 W
- White

### General characteristics

#### Hotel equipment - Arteor wiring devices square version

- Mechanisms supplied with rocker plates, to be equipped with support frames and plates

### Documentation



#### Catalogue pages & additional information

- [Description page \(p.440\)](#)



#### Agreements & certificates of conformity

- [QC / CB - FR\\_709182](#)



#### Installation & technical data

- [F00745EN-02](#)

CAT. N° 5 727 24

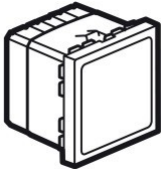

## ILLUMINATED SIGN ARTEOR - 1 W- 2-STATE LEDS GREEN/RED - 2 MODULES - MAGNESIUM

Pack (number of units)	5
Volume (dm <sup>3</sup> )	0,758
Weight (g)	226,00

### Product characteristics

#### Illuminated signs

- Mechanisms integrating LEDs and a pivoting window that can take customised labels (printed using a simple text editor on transparent printing paper)
- 2 modules

#### Green or red LEDs

- Sign with 2-state LEDs with choice of green or red configurable on the mechanism
- Power level: 1 W
- Magnesium

### General characteristics

#### Hotel equipment - Arteor wiring devices square version

- Mechanisms supplied with rocker plates, to be equipped with support frames and plates

### Documentation



#### Catalogue pages & additional information

- [Description page \(p.440\)](#)



#### Agreements & certificates of conformity

- [QC / CB - FR\\_709182](#)



#### Installation & technical data

- [F00745EN-02](#)

CAT. N° 5 727 46



## ILLUMINATED SIGN ARTEOR - 1 W- 2-STATE LEDS GREEN/RED - 2 MODULES - CHAMPAGNE

Pack (number of units)	O/R
Volume (dm <sup>3</sup> )	O/R
Weight (g)	O/R

### Product characteristics

#### Illuminated signs

- Mechanisms integrating LEDs and a pivoting window that can take customised labels (printed using a simple text editor on transparent printing paper)
- 2 modules

#### Green or red LEDs

- Sign with 2-state LEDs with choice of green or red configurable on the mechanism
- Power level: 1 W
- Champagne

### General characteristics

#### Hotel equipment - Arteor wiring devices square version

- Mechanisms supplied with rocker plates, to be equipped with support frames and plates

### Documentation



#### Installation & technical data

- [F00745EN-02](#)



#### Agreements & certificates of conformity

- [OC / CB - FR\\_709182](#)

CAT. N° 5 727 45



## ILLUMINATED SIGN ARTEOR - 1 W- 2-STATE LEDS GREEN/RED - 2 MODULES - SOFT ALU

Pack (number of units)	O/R
Volume (dm <sup>3</sup> )	O/R
Weight (g)	O/R

### Product characteristics

#### Illuminated signs

- Mechanisms integrating LEDs and a pivoting window that can take customised labels (printed using a simple text editor on transparent printing paper)
- 2 modules

#### Green or red LEDs

- Sign with 2-state LEDs with choice of green or red configurable on the mechanism
- Power level: 1 W
- Soft Alu

### General characteristics

#### Hotel equipment - Arteor wiring devices square version

- Mechanisms supplied with rocker plates, to be equipped with support frames and plates

### Documentation



#### Installation & technical data

- [F00745EN-02](#)



#### Agreements & certificates of conformity

- [OC / CB - FR\\_709182](#)

CAT. N° 5 727 22

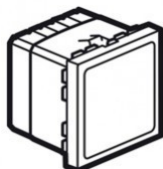

## ILLUMINATED SIGN ARTEOR - 0.2 OR 1 W- BLUE LEDS - 2 MODULES - MAGNESIUM

Pack (number of units)	5
Volume (dm <sup>3</sup> )	0,758
Weight (g)	207,00

### Product characteristics

#### Illuminated signs

- Mechanisms integrating LEDs and a pivoting window that can take customised labels (printed using a simple text editor on transparent printing paper)
- 2 modules

#### Blue LEDs

- Sign with blue LEDs
- A choice of 2 power levels: 0.2 or 1W
- Magnesium

### General characteristics

#### Hotel equipment - Arteor wiring devices square version

- Mechanisms supplied with rocker plates, to be equipped with support frames and plates

### Documentation

#### Catalogue pages & additional information

- [Description page \(p.440\)](#)

#### Agreements & certificates of conformity

- [OC / CB - FR\\_709182](#)

#### Installation & technical data

- [F00745EN-02](#)

CAT. N° 5 722 25



## ILLUMINATED SIGNS ARTEOR - 0.2 OR 1 W- BLUE LEDS - 2 MODULES - WHITE

Pack (number of units)	5
Volume (dm <sup>3</sup> )	0,758
Weight (g)	221,00

### Product characteristics

#### Illuminated signs

- Mechanisms integrating LEDs and a pivoting window that can take customised labels (printed using a simple text editor on transparent printing paper)
- 2 modules

#### Blue LEDs

- Sign with blue LEDs
- A choice of 2 power levels: 0.2 or 1W
- White

### General characteristics

#### Hotel equipment - Arteor wiring devices square version

- Mechanisms supplied with rocker plates, to be equipped with support frames and plates

### Documentation

#### Catalogue pages & additional information

- [Description page \(p.440\)](#)

#### Agreements & certificates of conformity

- [OC / CB - FR\\_709182](#)

#### Installation & technical data

- [F00745EN-02](#)

CAT. N° 5 727 48



## ILLUMINATED SIGN ARTEOR - 0.2 OR 1 W- BLUE LEDS - 2 MODULES - CHAMPAGNE

Pack (number of units)	5
Volume (dm <sup>3</sup> )	0,793
Weight (g)	204,00

### Product characteristics

#### Illuminated signs

- Mechanisms integrating LEDs and a pivoting window that can take customised labels (printed using a simple text editor on transparent printing paper)
- 2 modules

#### Blue LEDs

- Sign with blue LEDs
- A choice of 2 power levels: 0.2 or 1W
- Champagne

### General characteristics

#### Hotel equipment - Arteor wiring devices square version

- Mechanisms supplied with rocker plates, to be equipped with support frames and plates

### Documentation



#### Installation & technical data

- [F00745EN-02](#)



#### Agreements & certificates of conformity

- [OC / CB - FR\\_709182](#)

CAT. N° 5 727 47

**ILLUMINATED SIGN ARTEOR - 0.2 OR 1 W- BLUE LEDS - 2 MODULES - SOFT ALU**

Pack (number of units)	5
Volume (dm <sup>3</sup> )	0,793
Weight (g)	205,00

**Product characteristics****Illuminated signs**

- Mechanisms integrating LEDs and a pivoting window that can take customised labels (printed using a simple text editor on transparent printing paper)
- 2 modules

**Blue LEDs**

- Sign with blue LEDs
- A choice of 2 power levels: 0.2 or 1W
- Soft Alu

**General characteristics****Hotel equipment - Arteor wiring devices square version**

- Mechanisms supplied with rocker plates, to be equipped with support frames and plates

**Documentation****Installation & technical data**

- [F00745EN-02](#)

**Agreements & certificates of conformity**

- [OC / CB - FR\\_709182](#)



**Céliane™ - Arteur™**  
**LED lighting - Reading light**

Cat. No(s): 0 676 56/57 - 5 722 56/57 - 5 727 56/57

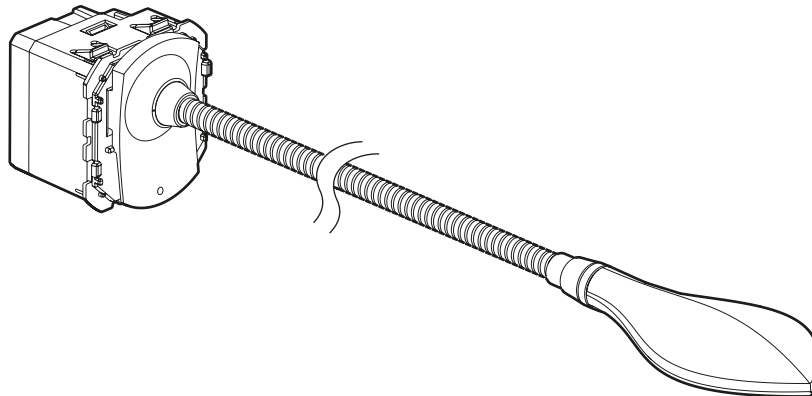

0 676 56/57

**1. USE**

For specific directionnal lighting in harmony with Céliane or Arteur wiring devices ranges.

**2. RANGE**

Description	Céliane		Arteur			
	White	Titane	White round	White square	Magnesium round	Magnesium square
Reading light: ideal for precise lighting headbed.	0 676 56	0 676 57	5 722 56	5 722 57	5 727 56	5 727 57

**3. PREPARATION**

P = 40 mm

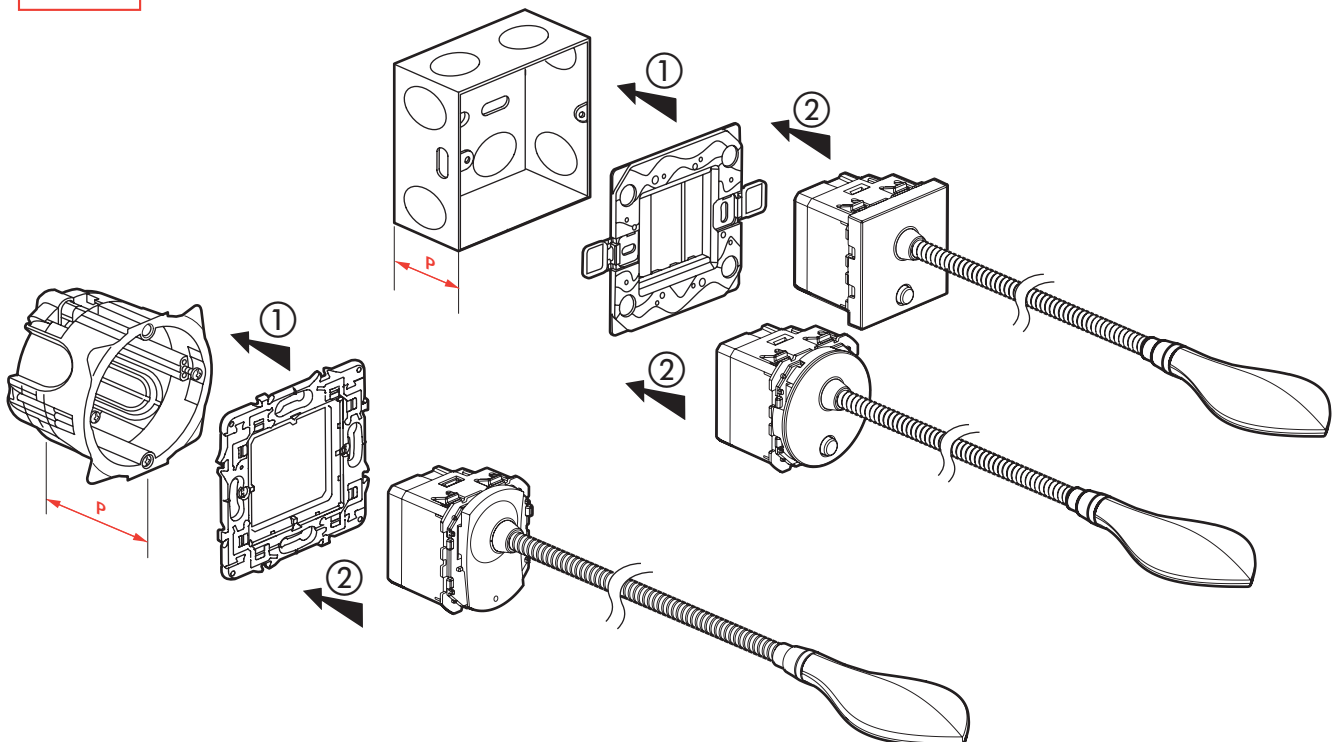

#### 4. OVERALL DIMENSIONS (mm)

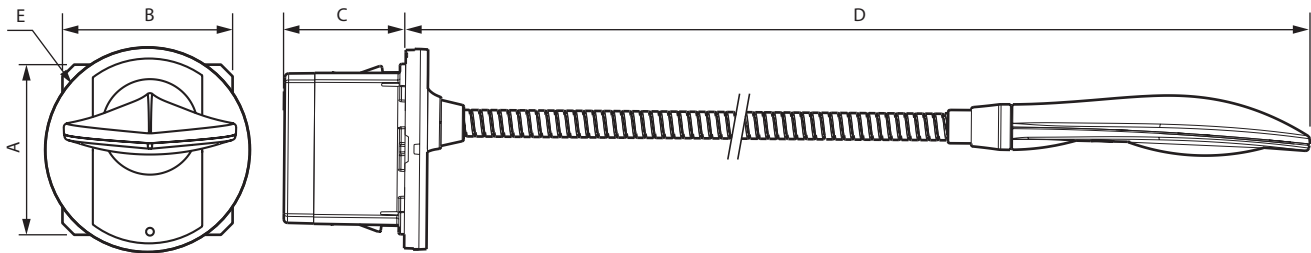

Cat. Nos	A	B	C	D	Ø E	□ E
0 676 56 - 0 676 57	45	45	32	330	53	-
5 722 56 - 5 727 56	45	45	32	330	45	-
5 722 57 - 5 727 57	45	45	32	390	-	45 x 45

#### 5. CONNECTION

Terminal capacity: 2 x 1.5 mm<sup>2</sup> or 2 x 2.5 mm<sup>2</sup>  
 Connection type: with screws  
 Screwdriver: Flat 3 mm  
 Stripping length: 8 mm  
 Tightening torque: 0.5 Nm

#### 6. TECHNICAL CHARACTERISTICS

##### ■ 6.1 Protection index

Penetration by solid bodies/liquid: IP 20 unassembled  
 IP 40 assembled

Impact test: IK 04

##### ■ 6.2 Material characteristics

Material:

- Cover: PC
  - Diffuser: PC
  - Painted cover, painted head reading light: ABS
  - Flexible: steel
- Halogen free.  
 UV resistant.

Self-extinguishing:

- + 850° C / 30 s for insulating parts holding live parts in place.
- + 650° C / 30 s for other parts made of insulating materials.

##### ■ 6.3 Electrical characteristics

Voltage: 230 VAC  
 Frequency: 50 Hz  
 Current: 23 mA  
 Luminous flux: 110 lm - Power input: 3.3 W  
 Color temperature: 3,000 K, neutral white  
 Product tested to 40,000 operations switching ON and OFF.  
 Reading lights have their own controls "ON/OFF/DIMMING" integrated.

#### 6. TECHNICAL CHARACTERISTICS (continued)

##### ■ 6.4 Photoelectric characteristics

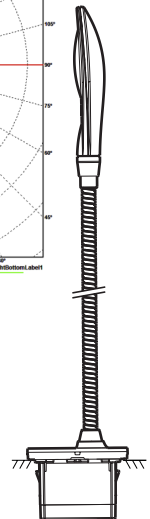
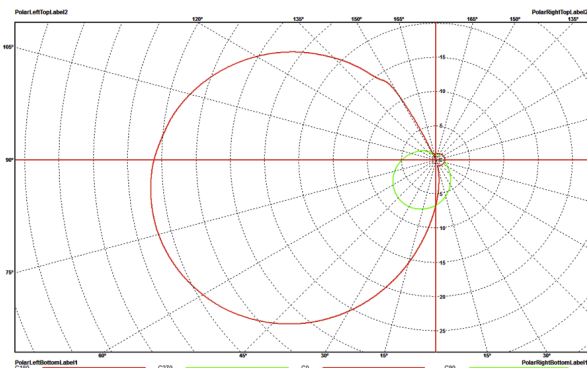

##### ■ 6.5 Climatic characteristics

Storage temperature: - 25° C to + 45° C  
 Use temperature: - 5° C to + 35° C

#### 7. CLEANING

Surface cleaning with a cloth.  
 Do not use: acetone, tar remover, trichloroethylene.

**Caution:** A preliminary test should be carried out if other specific cleaning products are to be used.

#### 8. STANDARDS AND APPROVALS

IEC 60598-1  
 IEC 60598-2-2  
 IEC 61547  
 IEC 60669-2-1