

EPIC® ULTRA H-B 6 AG LB

The robust and reliable industry connector housing as EMC version

EPIC® Rectangular connector housing EMC protection, corrosion resistant, UL50E, Nema250

Info

EMC protection
Corrosion-resistant
Made in Germany

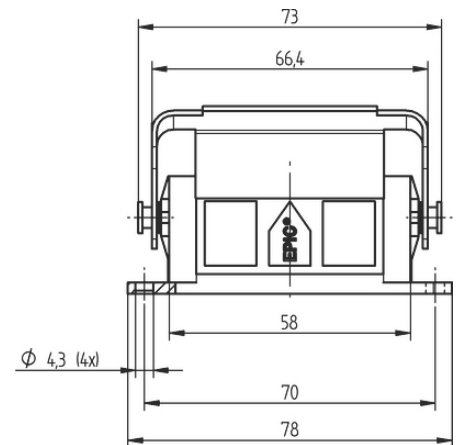
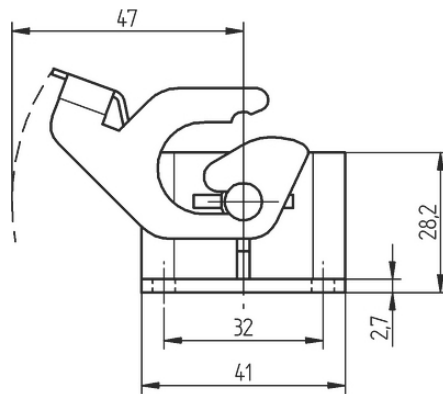

Good chemical resistance



Wide clamping range



Corrosion-resistant



Assembly time



Optimum strain relief



Space requirement



Robust



Integrated SKINTOP[®] cable gland

Last Update (25.12.2023)

©2023 Lapp Group - Technical changes reserved

Product Management www.lappkabel.de

You can find the current technical data in the corresponding data sheet.

PN 0456 / 02_03.16

EPIC® ULTRA H-B 6 AG LB



Connector with standard housing unit



Interference signals



Waterproof

Benefits

Optimum, low-resistance 360° screening
All-purpose due to high corrosion resistance and high environmental protection.
Space-saving due to compact dimensions.
Faster than any other comparable system
High mechanical resistance

Application range

In EMC-sensitive environments
For fixed and flexible applications (e.g. machinery building, wind turbines)
Construction machinery
Electric motor manufacturing

Product features

Housings with the BRUSH addition come with BRUSH cable screen contacting
Pluggable with standard housings
Corrosion-resistant according to DIN EN 6988
Resistance to cyclic salt spray is tested according to IEC 68-2-52, severity level 2
Salt spray testing according to DIN EN ISO 9227, method NSS, period of test 480 hours

Technical Data

Classification ETIM 5:	ETIM 5.0 Class-ID: EC000437 ETIM 5.0 Class-Description: Housing for industrial connectors
Classification ETIM 6:	ETIM 6.0 Class-ID: EC000437 ETIM 6.0 Class-Description: Housing for industrial connectors
Material:	Housing: nickel-plated zinc die-casting Lever and bolts: stainless steel Sealing: NBR Cable gland Body: nickel-plated brass Insert: PA Seal: special elastomer
Protection rating:	IP 65 NEMA 250, UL50E: 12, 4, 4X (latched)
Temperature range:	-40°C to +100°C

Note

Photographs and graphics are not to scale and do not represent detailed images of the respective products.
Prices are net prices without VAT and surcharges. Sale to business customers only.

EPIC® ULTRA H-B 6 AG LB

Article number	Article description	Pieces / PU
H-B housing: panel-mount base (single lever)		
70250206	ULTRA H-B 6 AG LB	1

Last Update (25.12.2023)

©2023 Lapp Group - Technical changes reserved

Product Management www.lappkabel.de

You can find the current technical data in the corresponding data sheet.

PN 0456 / 02_03.16