

LB PLUS busbar trunking systems

technical information

■ LB PLUS – Type A – 252/254/404

1.5 m - 2 outlets (single sided only)

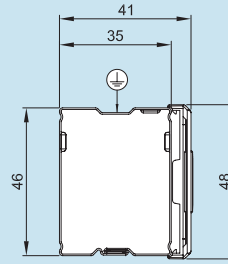
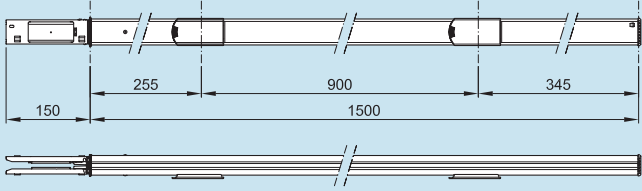

3 m - 2 outlets (single sided only)

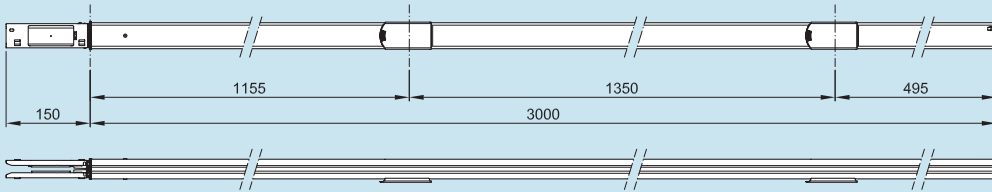

3 m - 4 outlets (single sided only)

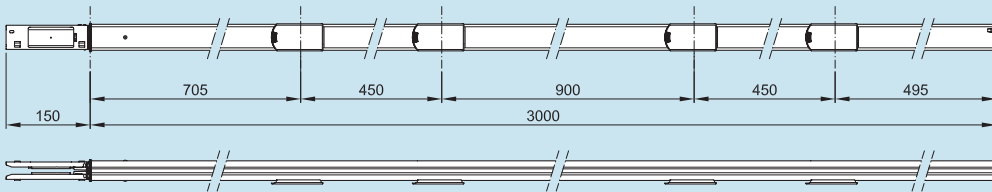

■ LB PLUS – Type B – 252/254/404

1.5 m - 2 outlets (single sided only)

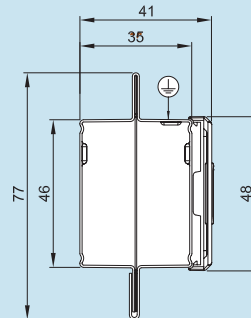
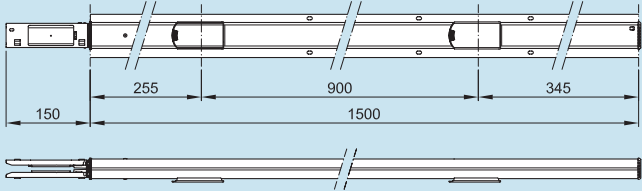

3 m - 4 outlets (single sided only)

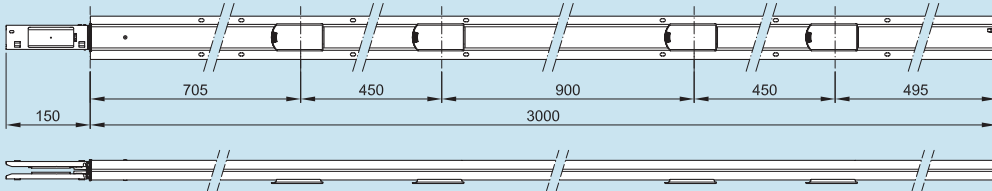

3 m - 6 outlets (single sided only)

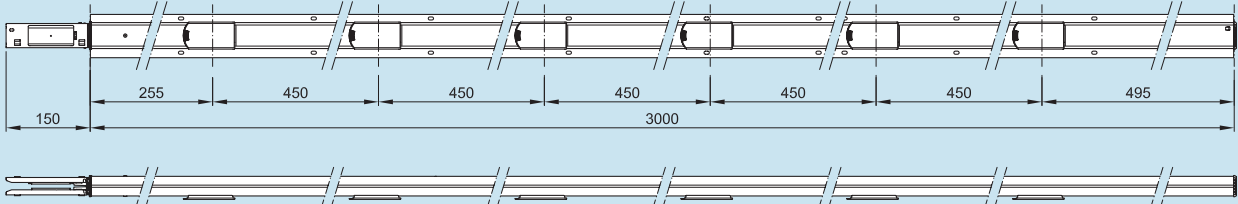

All dimensions (mm) are nominal

LB PLUS busbar trunking systems

technical information

■ LB PLUS – Type A – 256/258/408/634

1.5 m - 1+1 outlets (double sided)

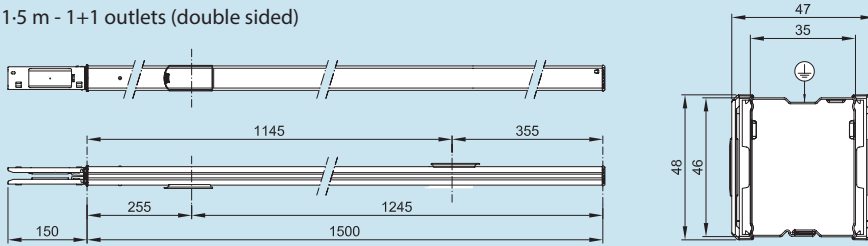

3 m - 2+2 outlets (double sided)

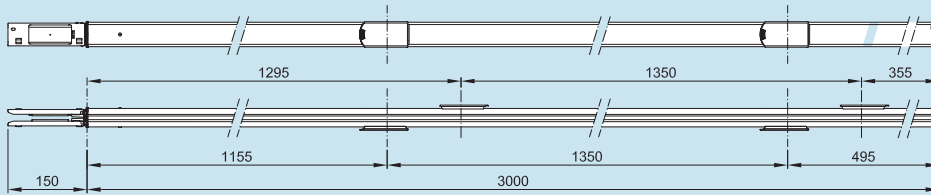

3 m - 4+4 outlets (double sided)

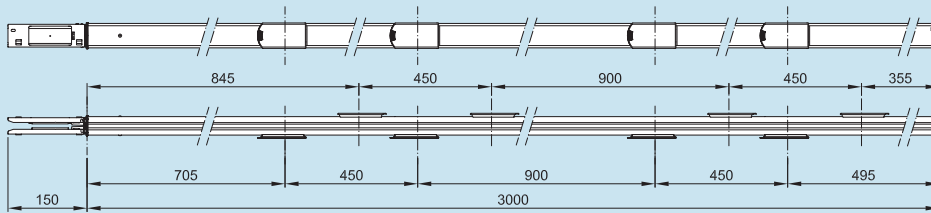

■ LB PLUS– Type B – 256/258/408/634

1.5 m - 1+1 outlets (double sided)

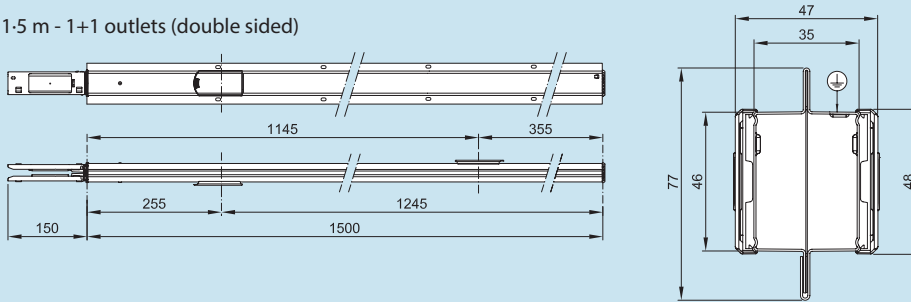

3 m - 4+4 outlets (double sided)

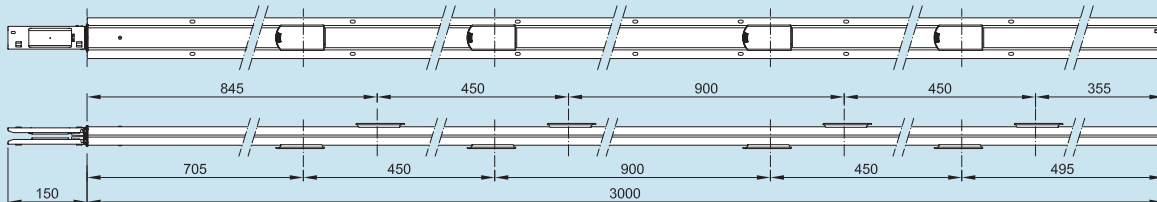

3 m - 6+6 outlets (double sided)

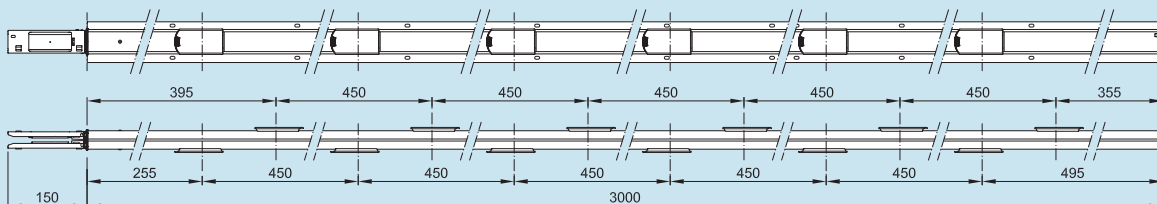

All dimensions (mm) are nominal